

5 た ち つ て と

1. よみましょう 

1) た ち つ て と

2) つ た て と ち

3) た て ち つ て と た と

4) と つ て た ち た つ て ち と

2. よみましょう 

1) たいいく

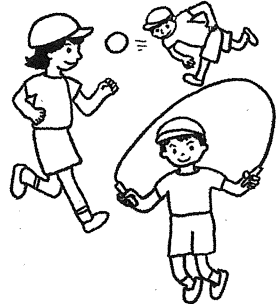

2) いち



3) くち

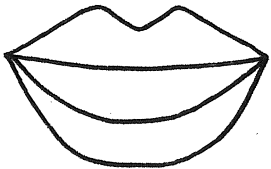

4) つくえ



5) て

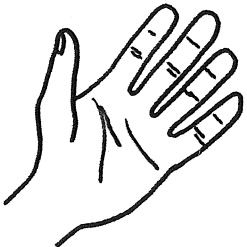

6) とけい

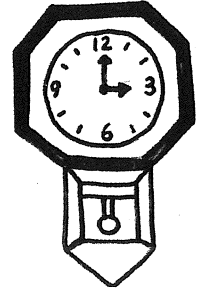

3. かきましょう



た

た ちつてと

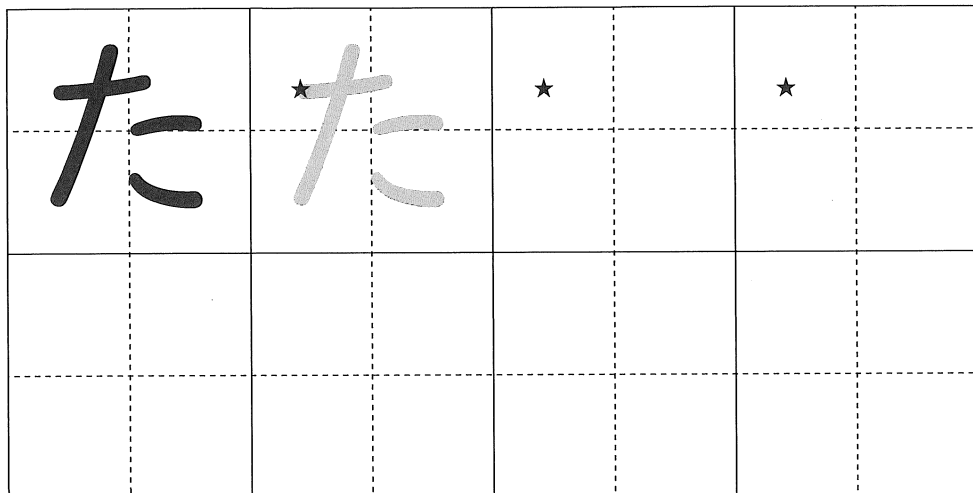
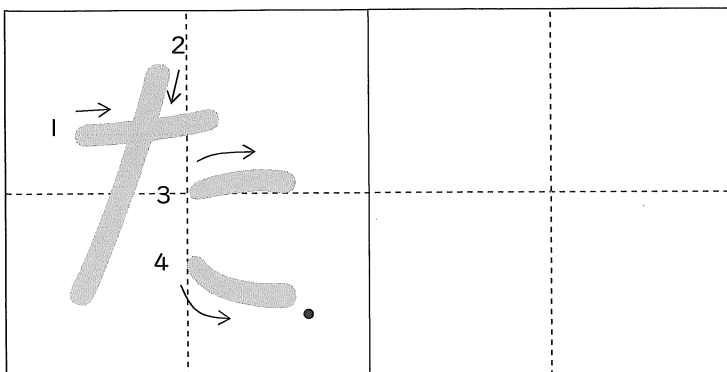

ち

た ち ちつてと

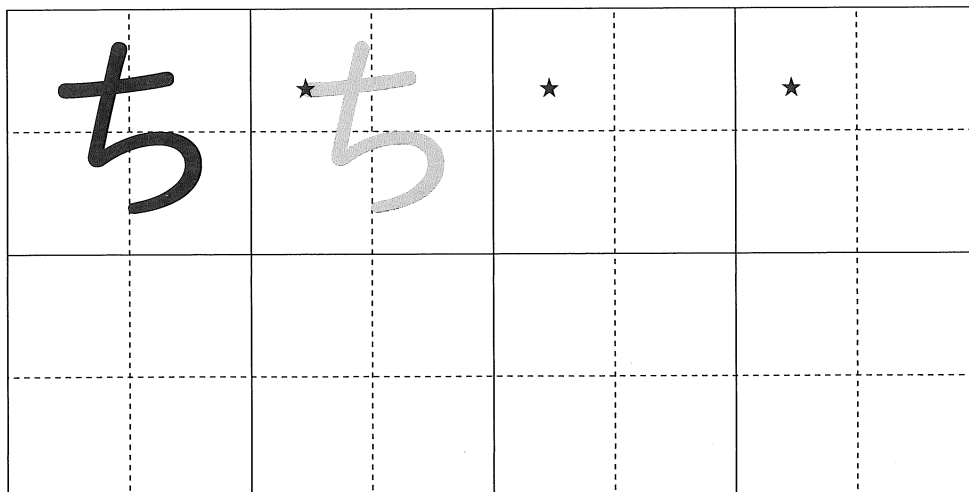
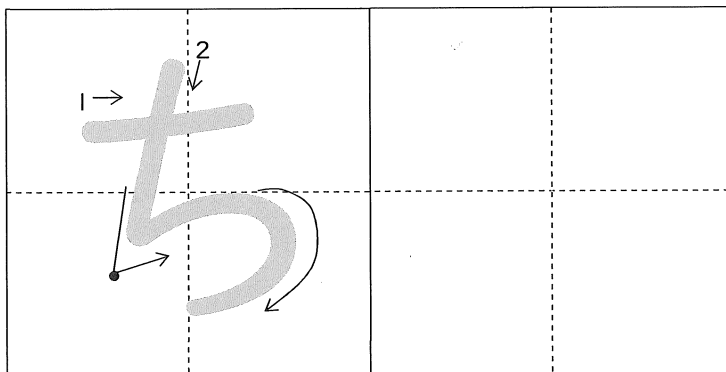

つ

たち ⊕ て と

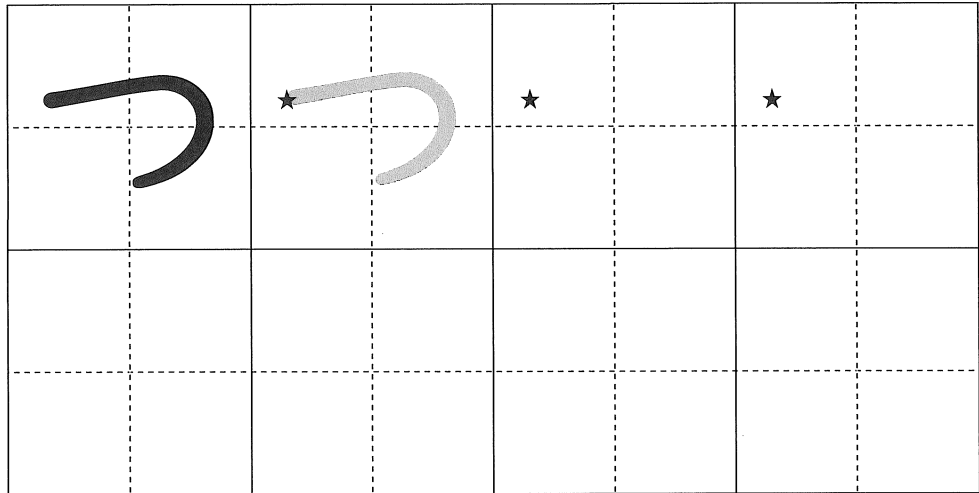
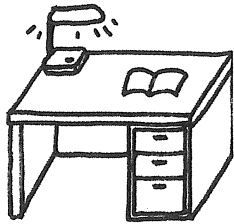
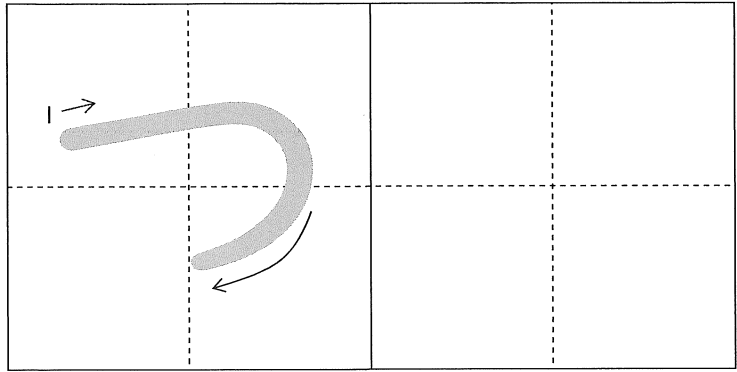

て

たち ⊕ て と

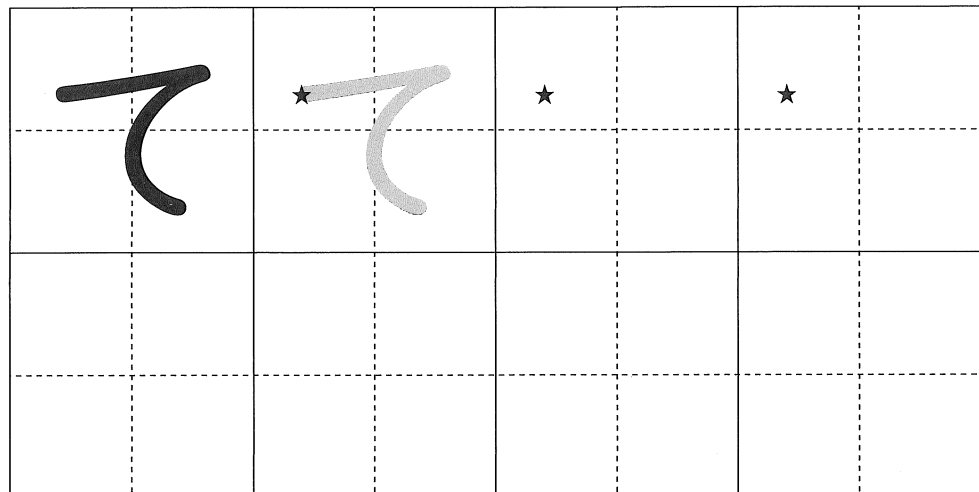
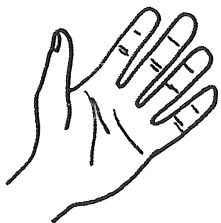
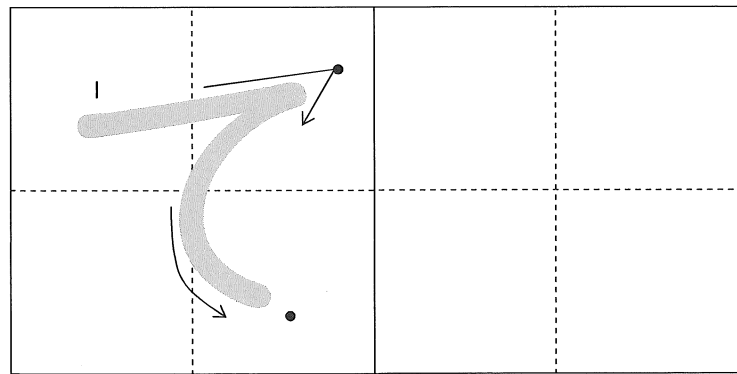

と

たちつてと

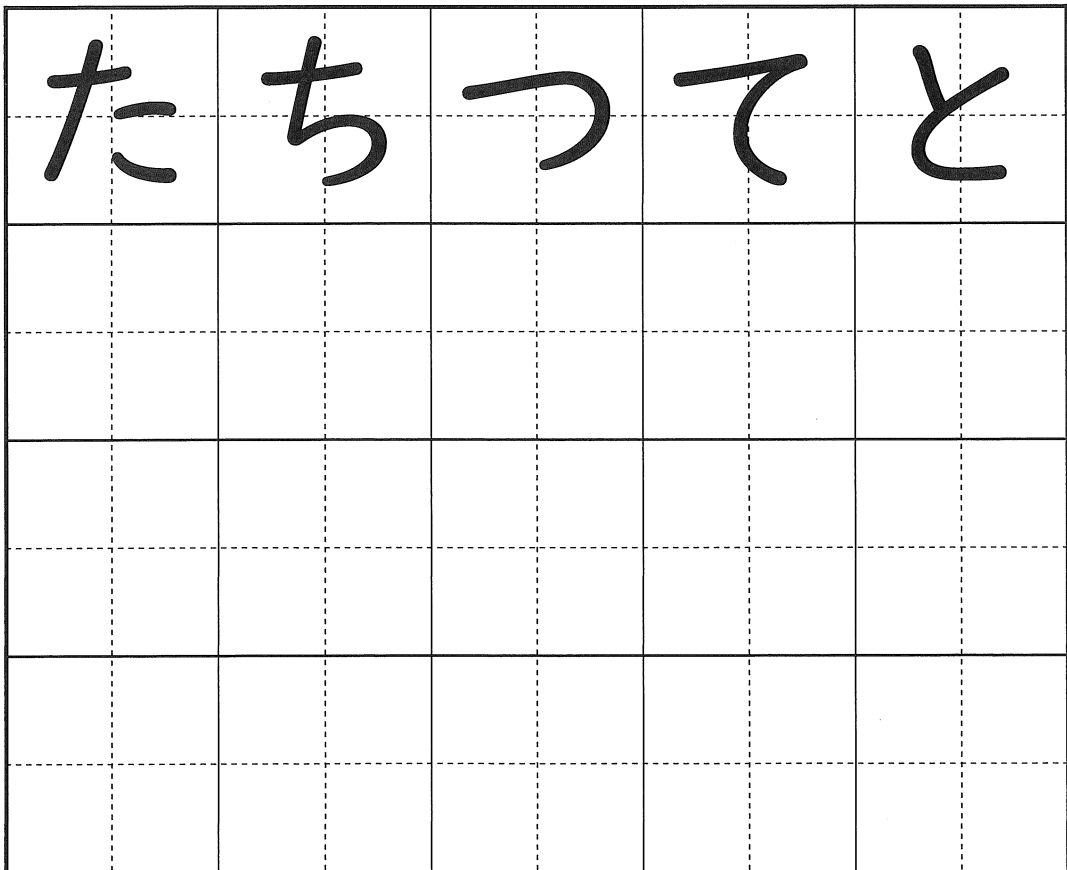
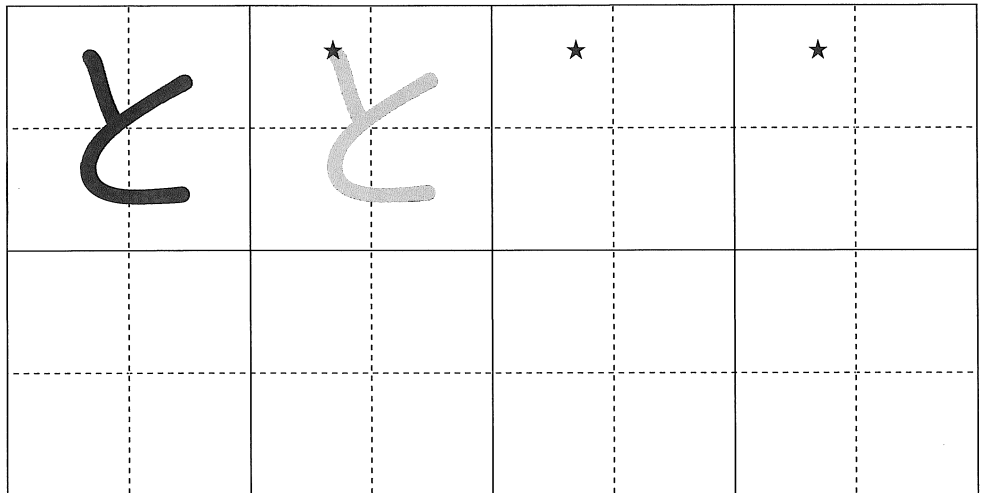
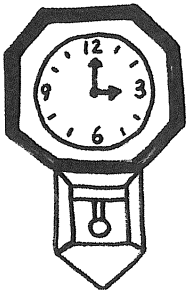
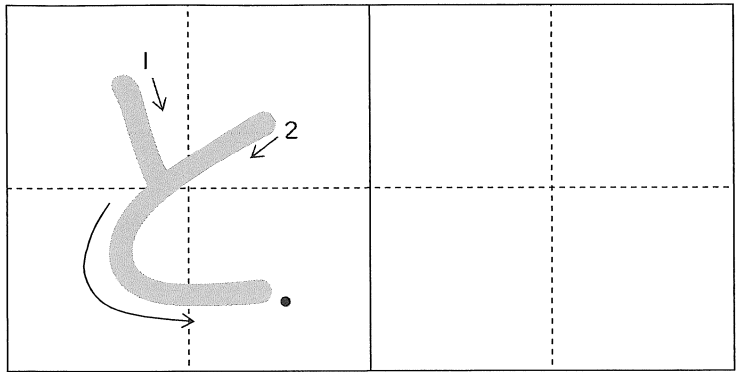

1)



た	い	い	く
---	---	---	---

2)



い
ち

い	ち
---	---

3)

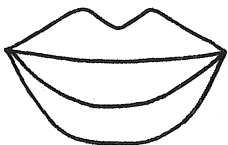

く
ち

く	ち
---	---

4)



つくえ

Blank handwriting practice grid for the word 'つくえ'.

つ

く

え

Blank handwriting practice grid for the word 'つくえ'.

5)



て

Blank handwriting practice grid for the character 'て'.

て

Blank handwriting practice grid for the character 'て'.

Blank handwriting practice grid for the character 'て'.

Blank handwriting practice grid for the character 'て'.

Blank handwriting practice grid for the character 'て'.

Blank handwriting practice grid for the character 'て'.

6)

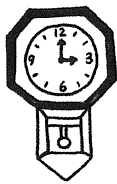

とけい

Blank handwriting practice grid for the word 'とけい'.

と

け

い

Blank handwriting practice grid for the word 'とけい'.



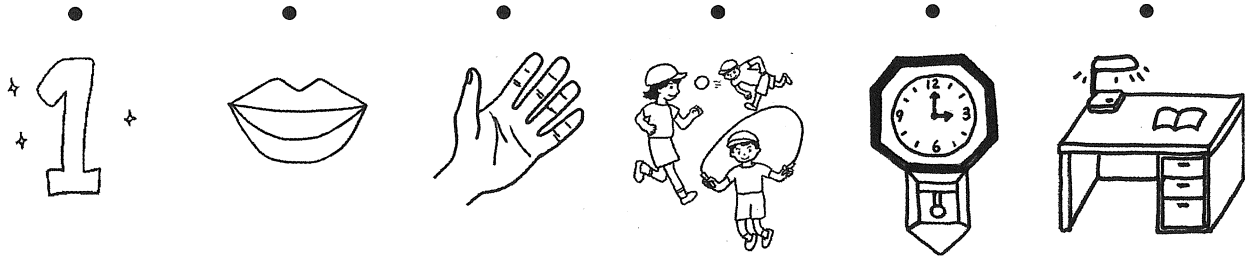

4. どれですか

いち たいいく つくえ て とけい くち

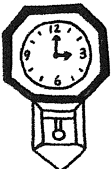

5. かきましよう 

④	③	②	①	
く	い	く	ち	ち
た	け	つ	い	く
い	と	え		
い				

				
				く ち

6. ききましょう かきましょう

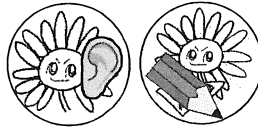

1)

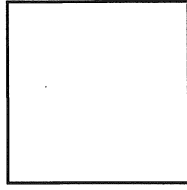
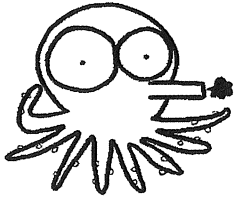

こ

2)

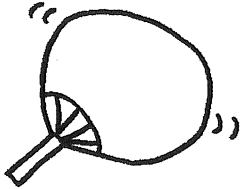

う

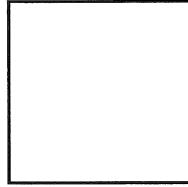

わ

3)

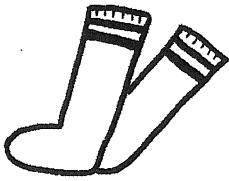

く

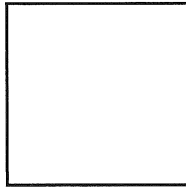

し

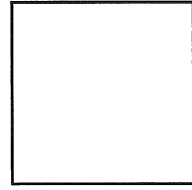

4)

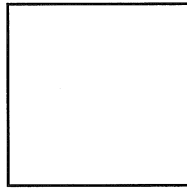
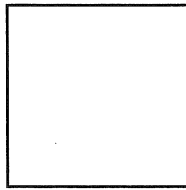

ぼう

5)

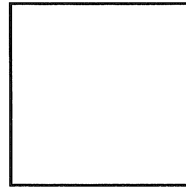
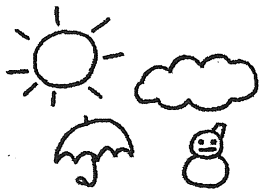

んき

6)

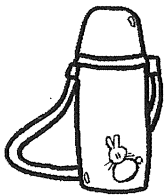

すい

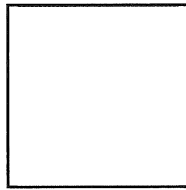

う

7)

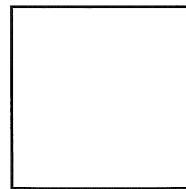

8)

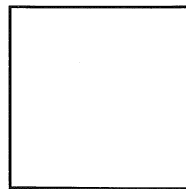
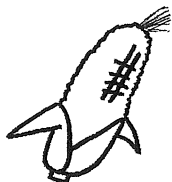

うもろこし

6 なにぬねの

1. よみましょう 

1) な に ぬ ね の

2) ぬ な ね の に

3) な ね に ぬ ね の な の

4) の ぬ ね な に な ぬ ね に の

2. よみましょう 

1) さかな

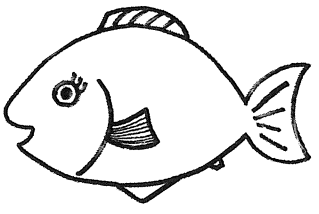

2) かに

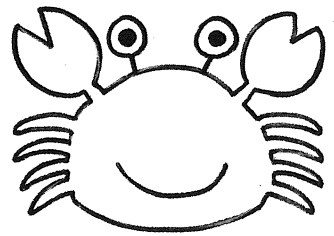

3) いぬ



4) ねこ

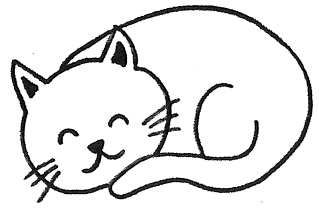

5) おかね



6) きのこ

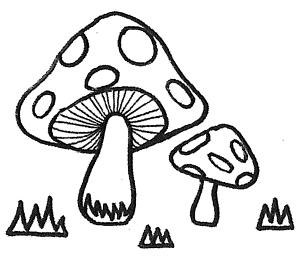

3. かきましよう



な

な にぬねの

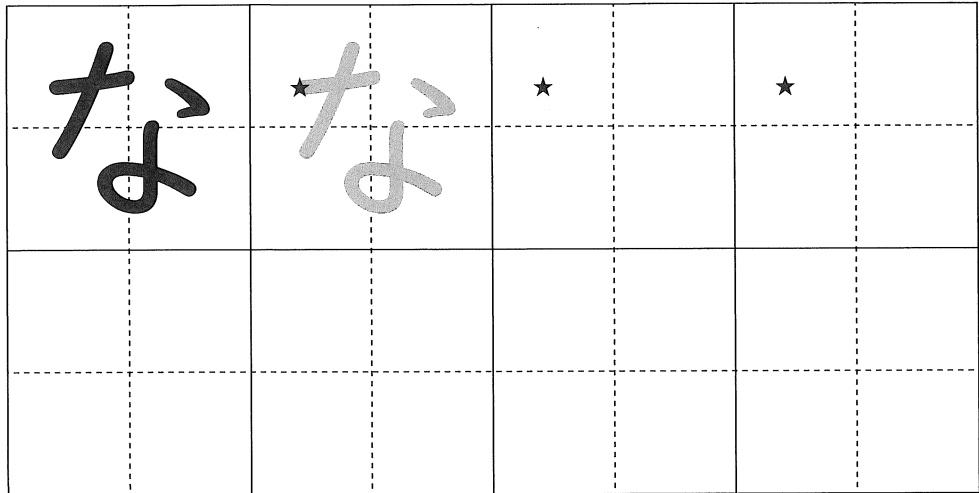
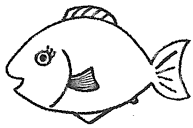
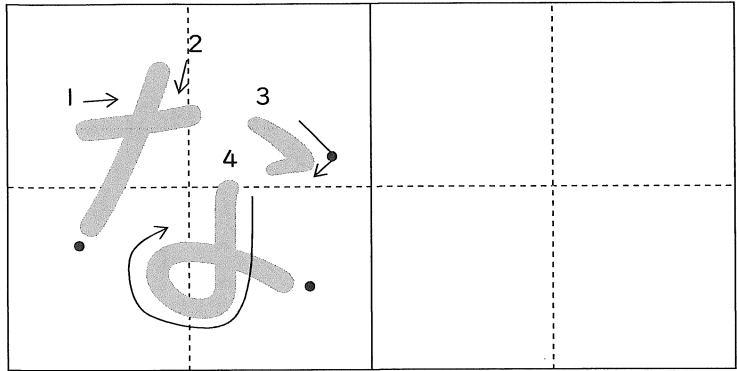

に

な にぬねの

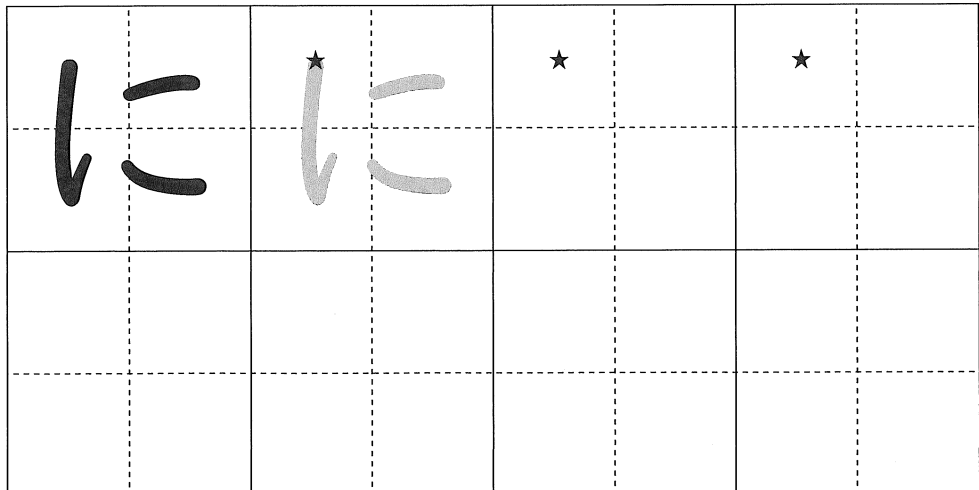
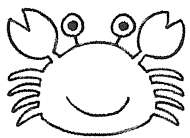
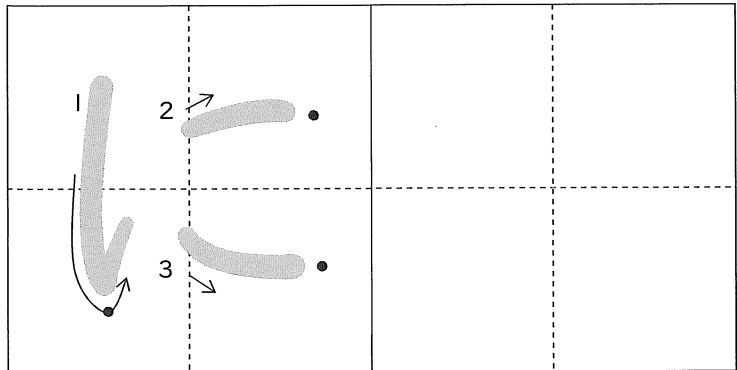

ぬ

なにぬねの

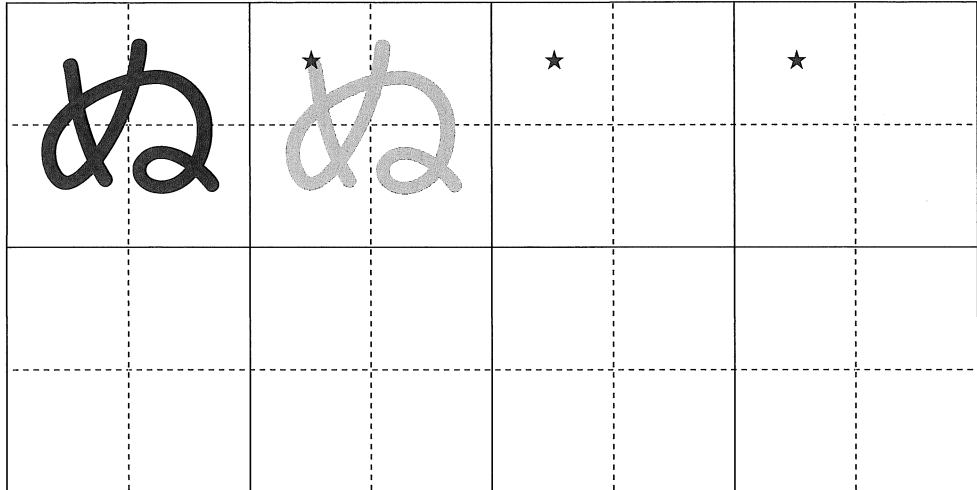
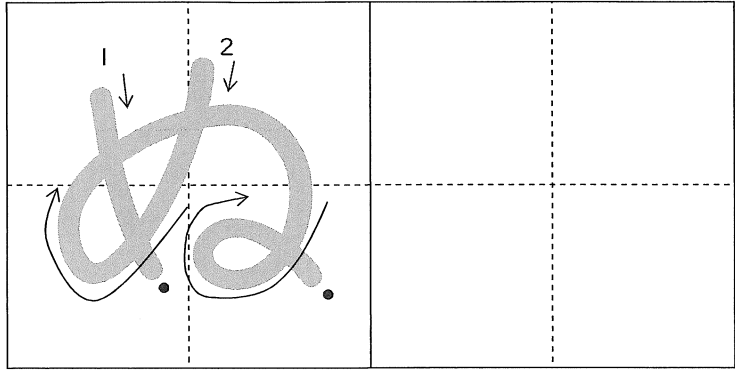

ね

なにぬねの

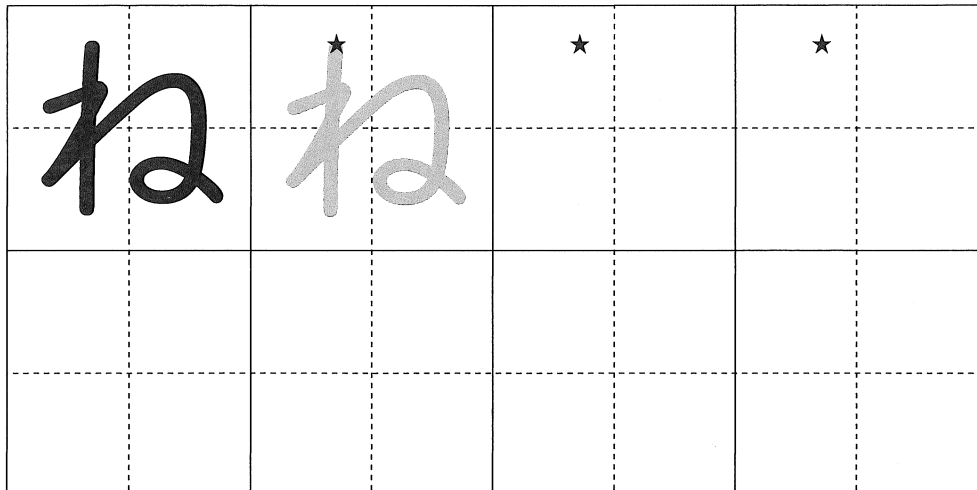
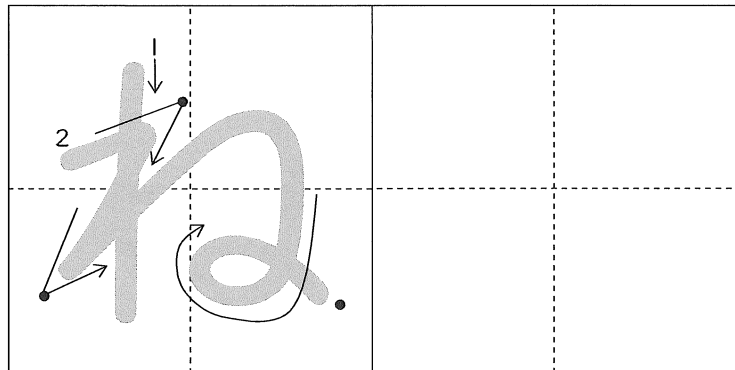

の

なにぬねの

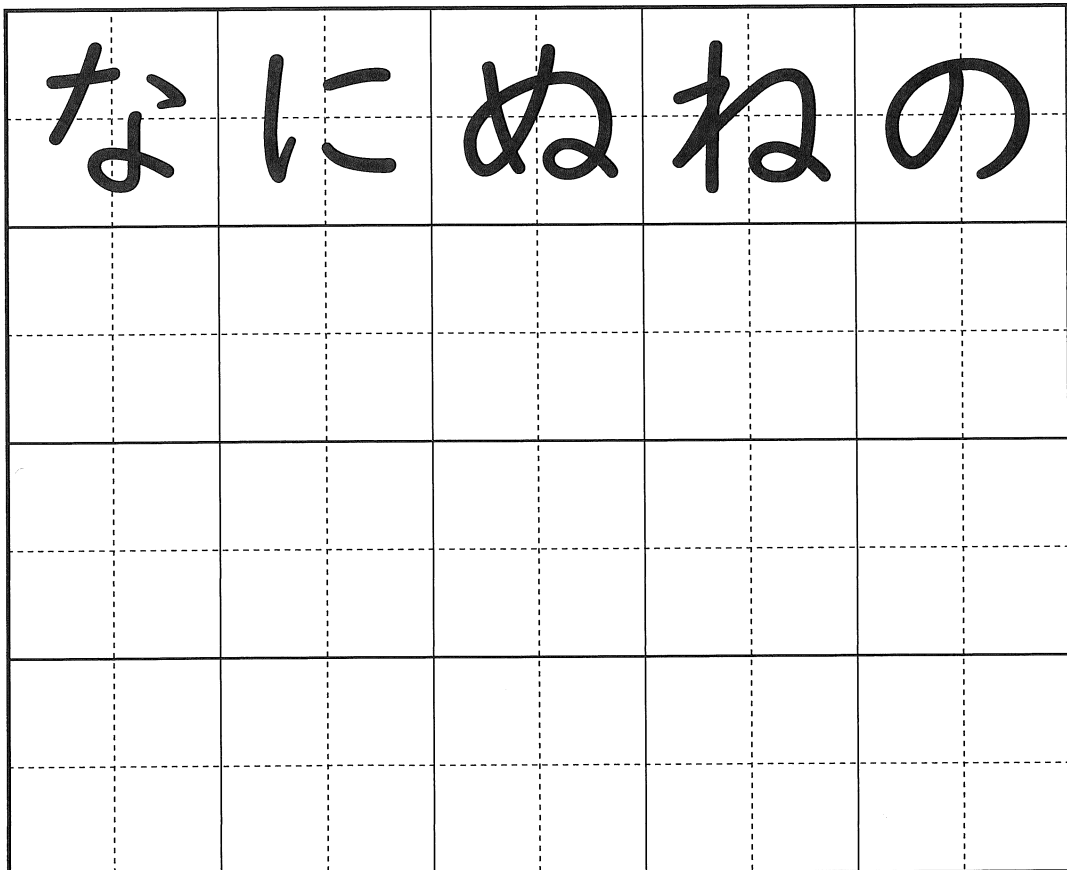
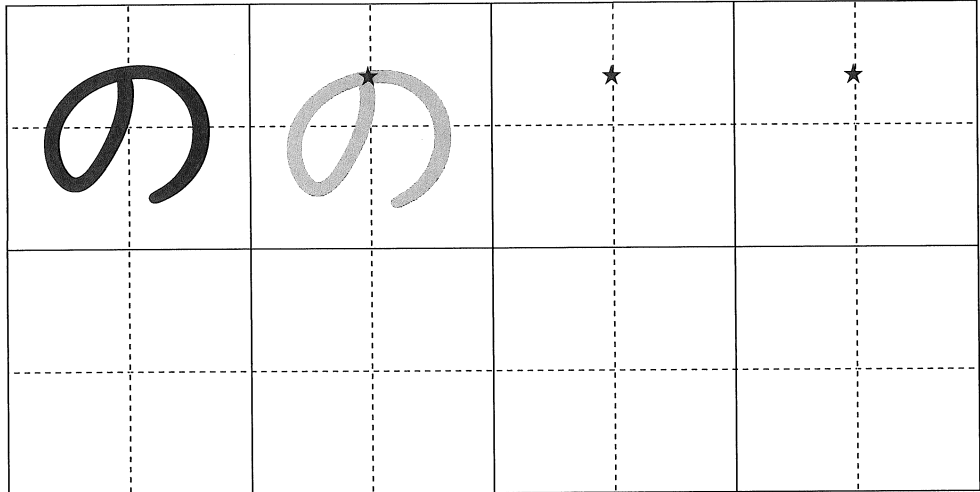
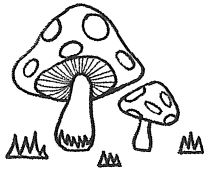
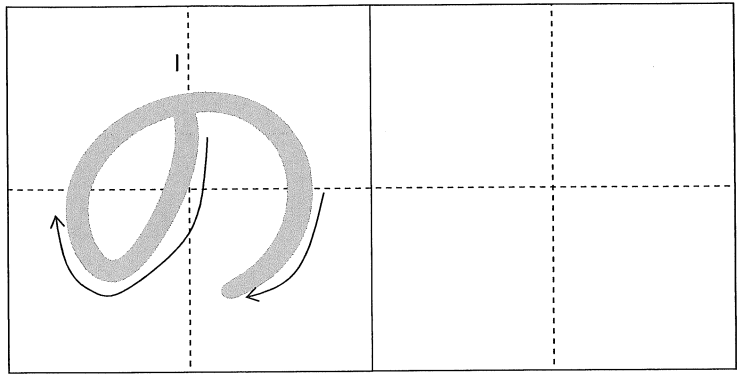

1)

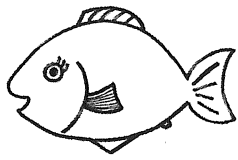

さかな

Blank handwriting practice box for the word 'sakan' (fish).

さ
か
な

Blank handwriting practice box for the word 'sakan' (fish).

2)

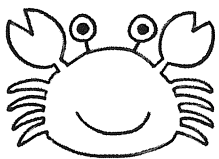

かに

Blank handwriting practice box for the word 'kani' (crab).

か
に

Blank handwriting practice box for the word 'kani' (crab).

3)



いぬ

Blank handwriting practice box for the word 'inu' (dog).

い
ぬ

Blank handwriting practice box for the word 'inu' (dog).

4)



ね こ

ね こ

ね こ

ね こ

5)



お かね

お かね

お かね

お かね

6)



きのこ

きのこ

きのこ

きのこ

4. どれですか

いぬ さかな ねこ おかね かに きのこ

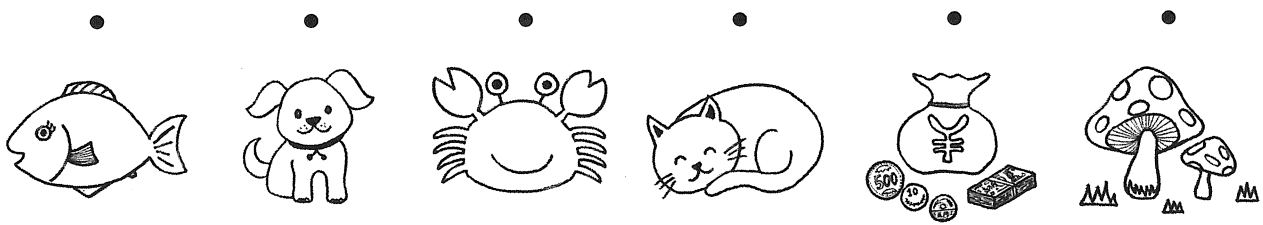

5. かきましょう



④ ③ ② ① に
 な の お ぬ
 さ き ね い か
 か こ か

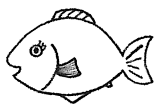

				か
				に

6. ききましょう かきましょう

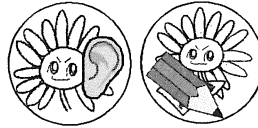

1)

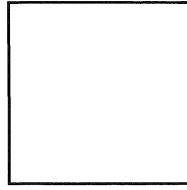
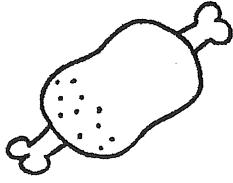

く

2)

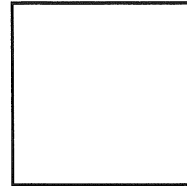
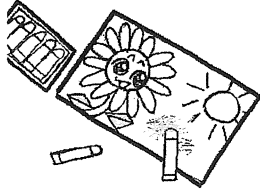

りえ

3)

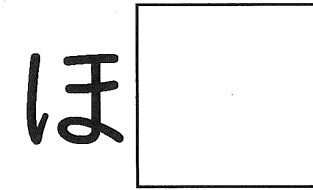
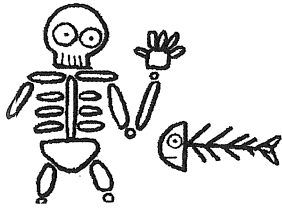

4)

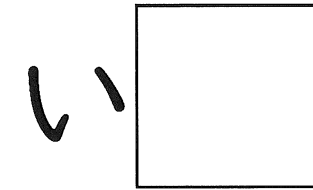
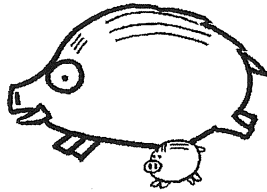

しし

5)

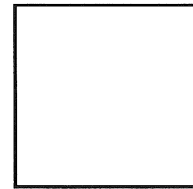
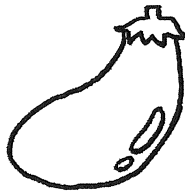

す

6)

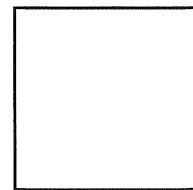
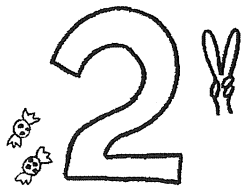

7)

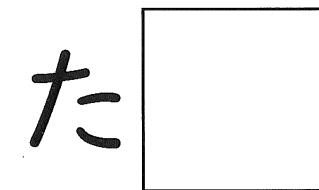

き

8)

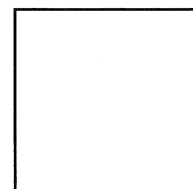

わとび

7 は ひ ふ へ ほ

1. よみましょう 

1) は ひ ふ へ ほ

2) ふ は へ ほ ひ

3) は へ ひ ふ へ ほ は ほ

4) ほ ふ へ は ひ は ふ へ ひ ほ

2. よみましょう 

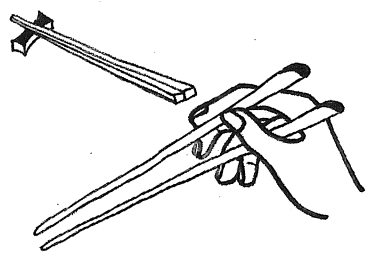
1) はし 

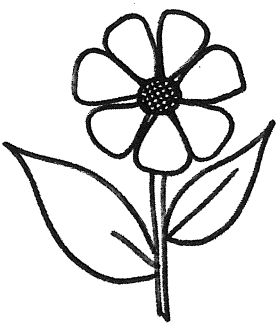
2) はな 

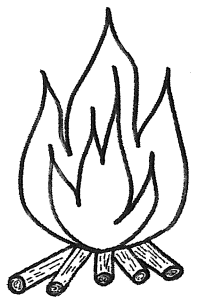
3) ひ 

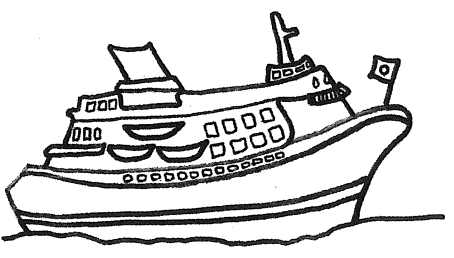
4) ふね 

5) へそ 

6) ほし 

3. かきましょう



は

は ひ ふ へ ほ

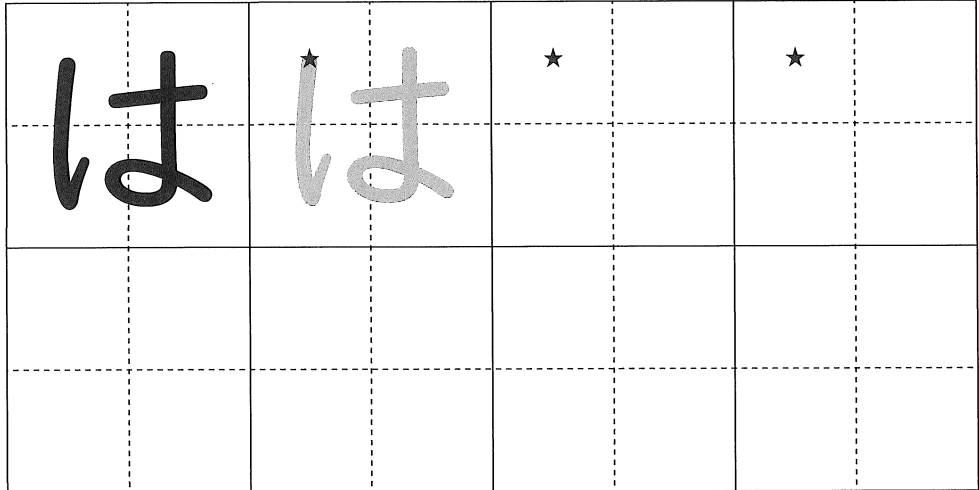
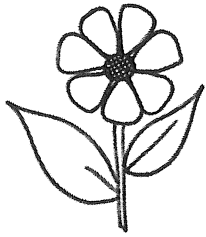
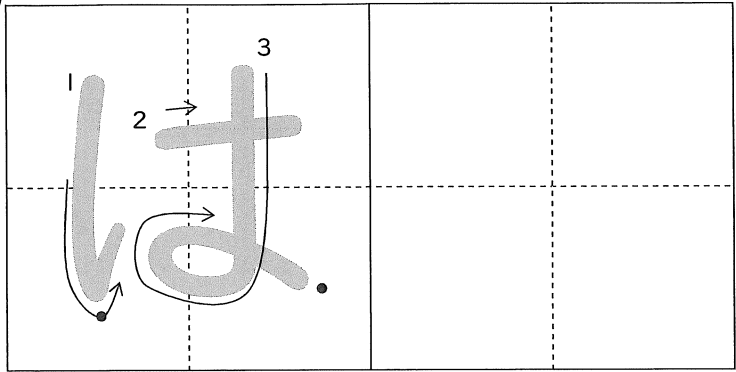

ひ

は ひ ふ へ ほ

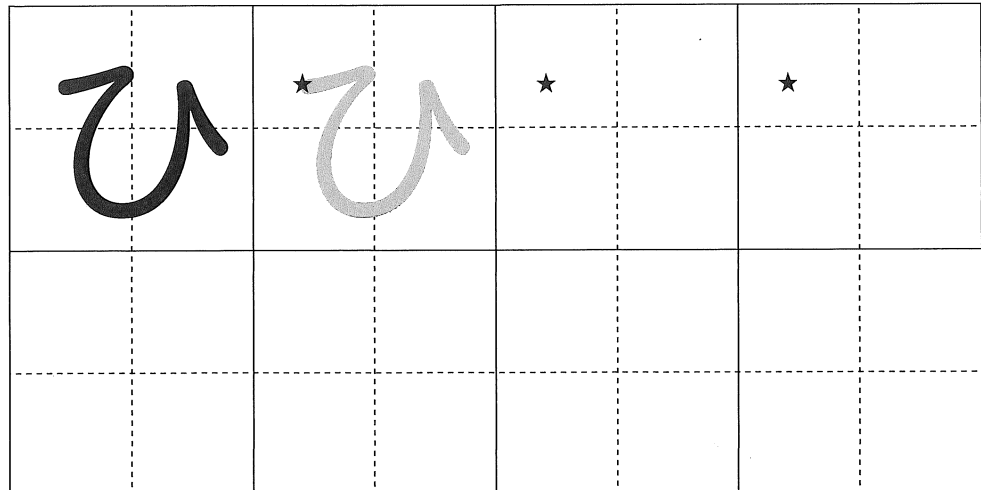
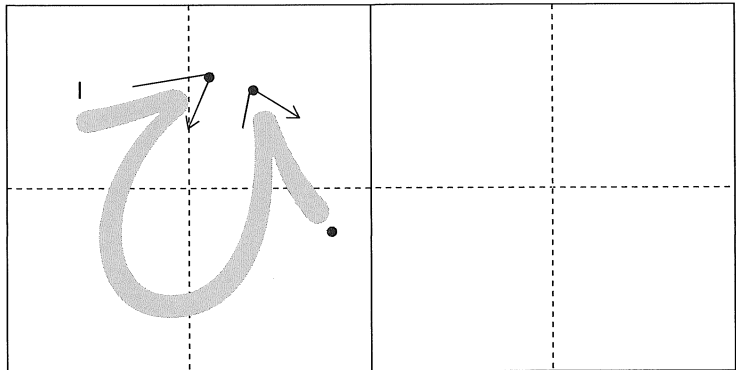

はひふへほ

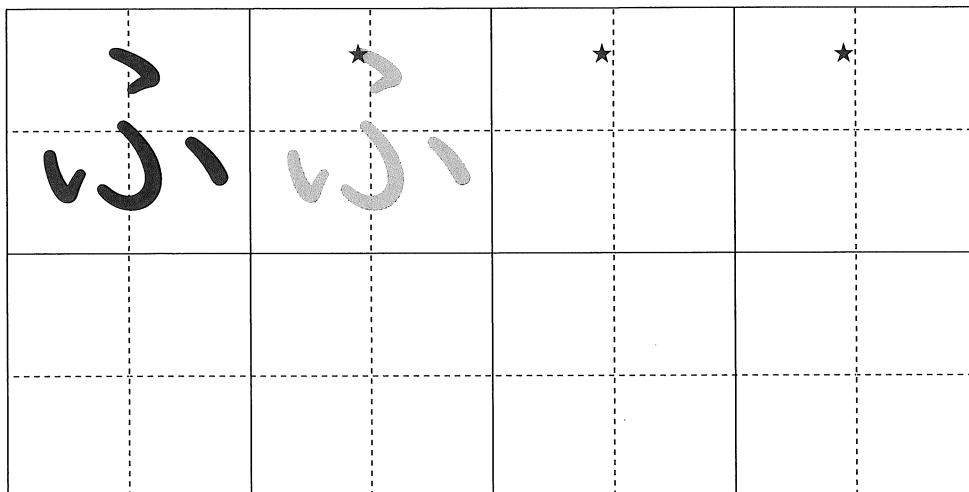
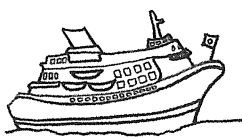
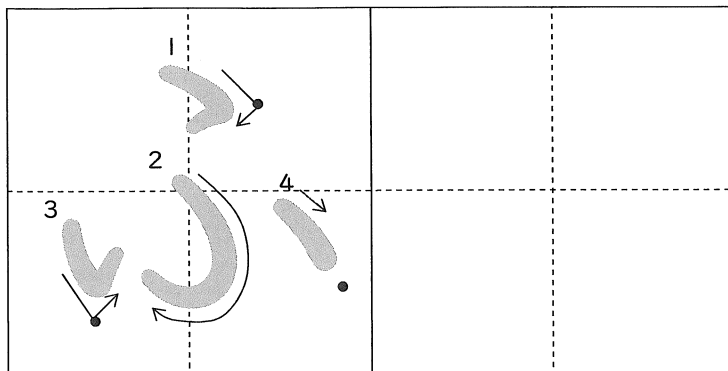

はひふへほ

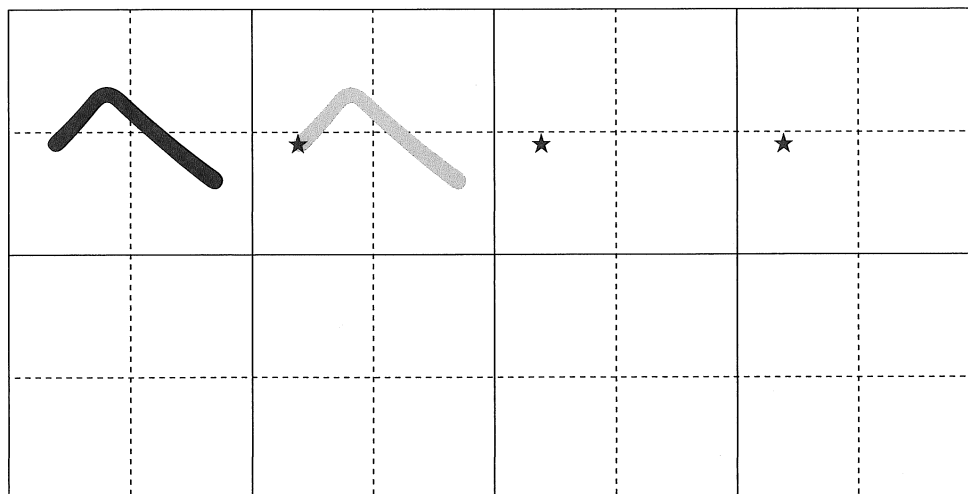
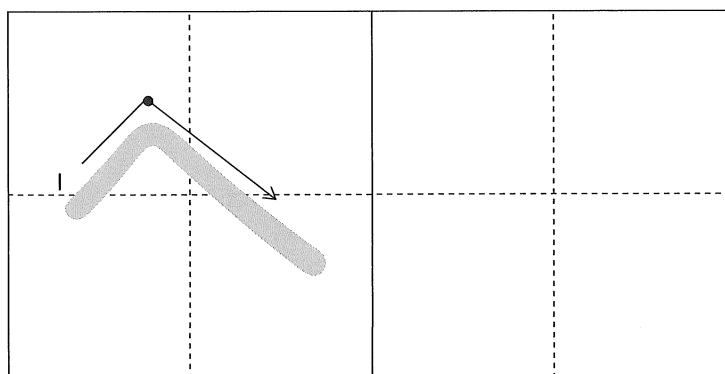

ほ

はひふへ ほ

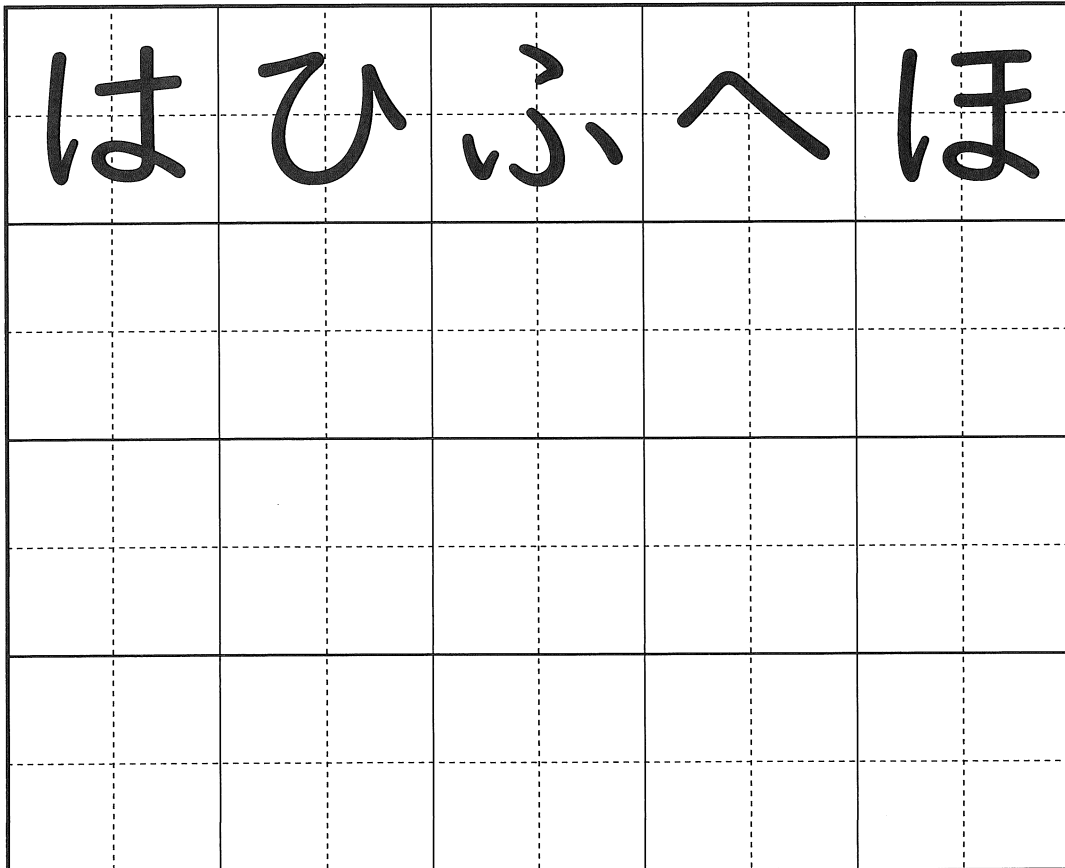
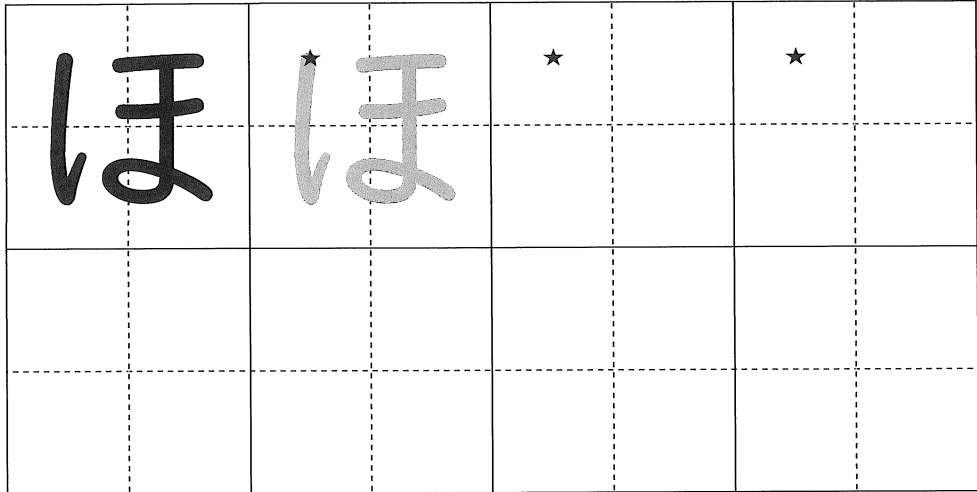
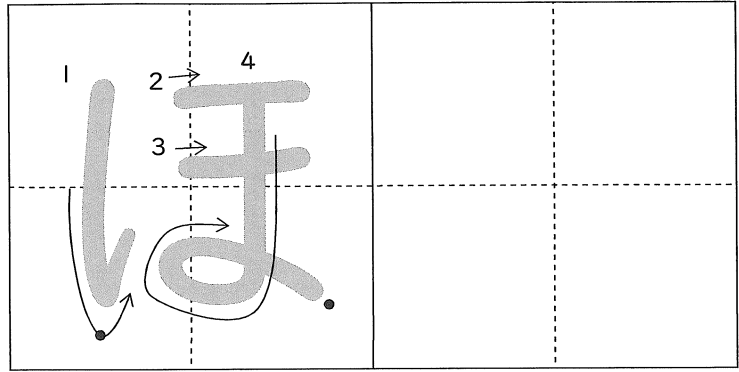

1)

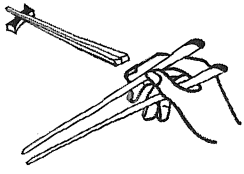

は し

は

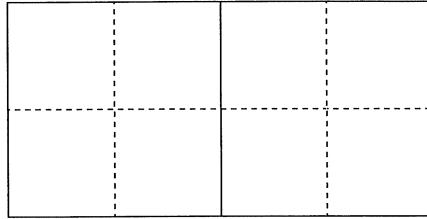
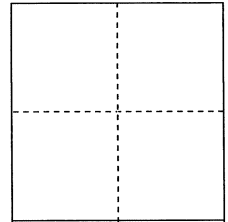

し

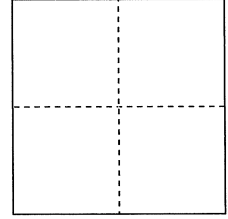

2)

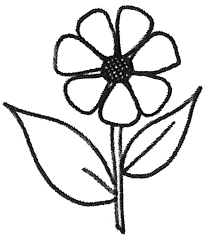

は な

は

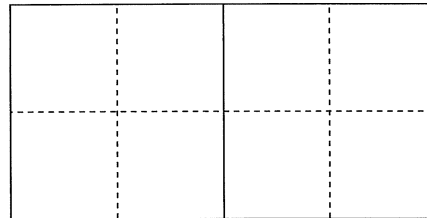
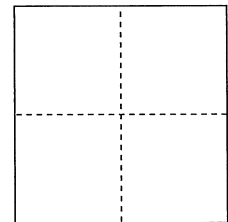

な

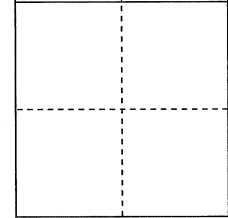

3)



ひ

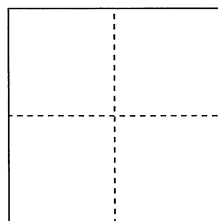

ひ

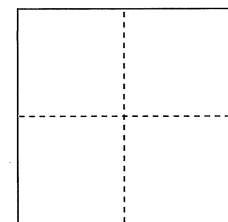
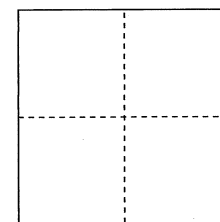
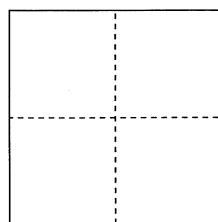
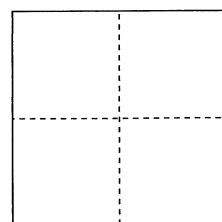
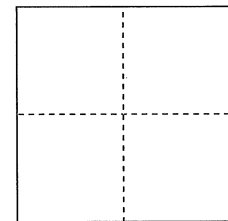

4)

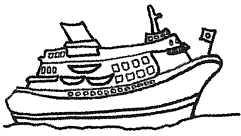

ふね

Blank handwriting practice box for the word 'ふね'.

ふ

ね

Blank handwriting practice box for the character 'ふ'.

Blank handwriting practice box for the character 'ね'.

5)



へそ

Blank handwriting practice box for the word 'へそ'.

へ

そ

Blank handwriting practice box for the character 'へ'.

Blank handwriting practice box for the character 'そ'.

6)



ほし

Blank handwriting practice box for the word 'ほし'.

ほ

し

Blank handwriting practice box for the character 'ほ'.

Blank handwriting practice box for the character 'し'.

4. どれですか

ふね
●

ひ
●

はし
●

へそ
●

はな
●

ほし
●

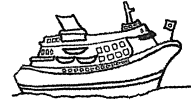
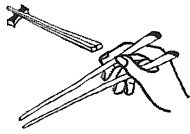

5. かきましょう



④
な

③
そ

②
ね

①
し

し

は

へ

ふ

は

ほ

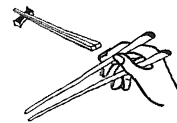
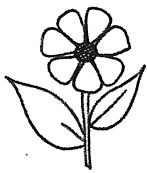

ほ
し

6. ききましょう かきましょう

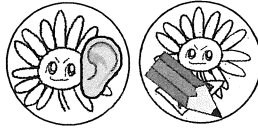

1)

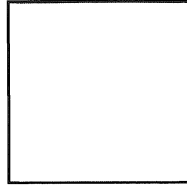

な

2)

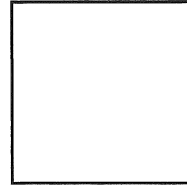

び

3)

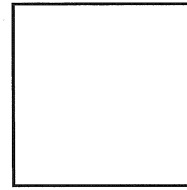

うせん

4)



あ

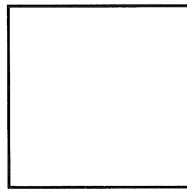

る

5)

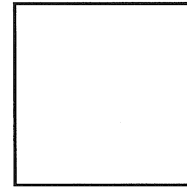
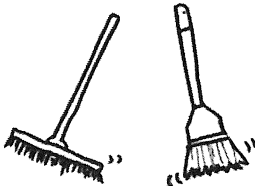

うき

6)

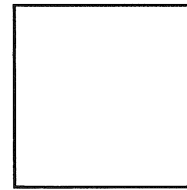

さみ

7)

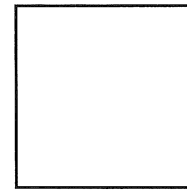
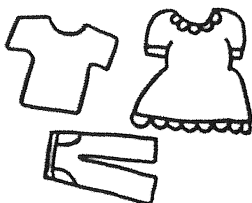

く

8)

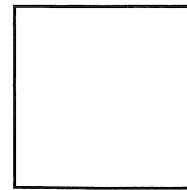
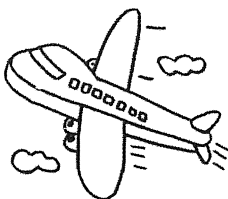

こうき

チェックシート② た行～は行

よみましょう

指導される方へ：文字やことばを見童に読ませ、
チェックしてください。

		チェック				チェック	
		月 日	月 日			月 日	月 日
①	へ			⑪	た		
②	て			⑫	の		
③	な			⑬	と		
④	ほ			⑭	に		
⑤	は			⑮	つ		
⑥	ち			⑯	ふね		
⑦	ふ			⑰	はな		
⑧	ね			⑱	とけい		
⑨	ぬ			⑲	つくえ		
⑩	ひ			⑳	たいいく		

*** やって みましょう *****
えにあうように □に もじを かきましょう。

1) 

ふ
こ

2)

く
い



き
く
え



3)

は
さ
か



1

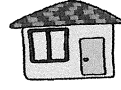

ぬ



4)

さ
か



がつ にち () ようび なまえ

チェックシート② た行～は行

指導される方へ：前ページの「よみましょう」の中の文字やことばを選び、指導者が読んで児童に書かせてください。

きいて かきましょう

①		②		③		④	
⑤		⑥		⑦		⑧	
⑨		⑩		⑪		⑫	
⑬		⑭		⑮			



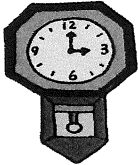

【ひとやすみ②】

しりとりをしながら □に もじをかきましょう。

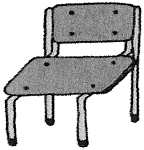
とけ  □

 □

す  □

さ  □

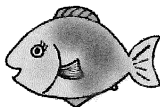
さか  □

すい  □

まえ  □



なまえは？

じぶんの なまえを
かきましょう。

です。